

Renewal Parts for 800H NEMA 4/4X Operators

Mounting Hardware for Bulletin 800H NEMA 4/4X Operators

Locking or Mounting Ring

Thrust Washer

Trim Washer

Rubber Gasket



(Pictures are for illustration only. The exact size and dimensions will vary depending upon the catalog number)

CATALOG NUMBER	DESCRIPTION	LOCKING RING ①	THRUST WASHER	TRIM WASHER	GASKET
800H-AR***	Flush Head Pushbutton	800H-N144	800H-N146	800H-N148	F-14963
800H-BR***	Extended Head Pushbutton	800H-N144	800H-N146	800H-N148	F-14963
800H-DR***	Mushroom Head Pushbutton	800H-N142	800H-N146	800H-N148	F-14963
800H-DR*J	Jumbo Plastic Mushroom Head	800H-N142	800H-N146	800H-N148	F-14963
800H-FRX****	Push Pull Devices – All	800H-N142	800H-N146	800H-N148	F-14963
800H-GR**	Guarded Pushbutton	800H-N143	800H-N146	800H-N148	F-14963
800H-H, -J, or -N	Selector Switch – Std Knob	800H-N145F	800H-N146	800H-N148	F-14963
800H-PR***	Pilot Light Transformer Unit	800H-N149	800H-N146	800H-N148	F-14963
800H-PRA**	Illum Pushbutton with Guard ②	800H-N152	800H-N146	800H-N148	F-14963
800H-PRB***	Illum Pushbutton w/o Guard	800H-N142	800H-N146	800H-N148	F-14963
800H-PRDT**	Dual Input Pilot Light	800H-N149	800H-N146	800H-N148	F-14963
800H-PRM**	Illum Mushroom Head Pushbutton	800H-N142	800H-N146	800H-N148	F-14963
800H-PRMJ**	Illum Jumbo Mushroom Head Pushbutton	800H-N142	800H-N146	800H-N148	F-14963
800H-PRT***	Push-to-Test Pilot Light	800H-N142	800H-N146	800H-N148	F-14963
800H-QR***	Pilot Light Full Voltage Unit	800H-N149	800H-N146	800H-N148	F-14963
800H-QRA**	Illum Pushbutton with Guard ②	800H-N152	800H-N146	800H-N148	F-14963
800H-QRB***	Illum Pushbutton w/o Guard	800H-N142	800H-N146	800H-N148	F-14963
800H-QRM**	Illum Mushroom Head Pushbutton	800H-N142	800H-N146	800H-N148	F-14963
800H-QRMJ**	Illum Jumbo Mushroom Head Pushbutton	800H-N142	800H-N146	800H-N148	F-14963
800H-QRT***	Push-to-Test Pilot Light	800H-N142	800H-N146	800H-N148	F-14963
800H-R**	Booted Pushbutton	Not Used	800H-N146	800H-N148	F-14963
800H-RR**	Neon Pilot Light	800H-N149	800H-N146	800H-N148	F-14963
800H-UR**	Potentiometer Units – All	800H-N143	800H-N146	800H-N148	F-14963
800H-WK**	Flip Lever Operator ③	40271-135-01	Not Used	Not Used	F-21013
800H-**HR**	Illum 2 Position Selector Switch	40209-065-01	800H-N146	800H-N148	F-14963
800H-**JR**	Illum 3 Position Selector Switch	40209-065-01	800H-N146	800H-N148	F-14963

① Locking Ring repair parts are for Series F units.

② The 800H-N152 kit includes the octagonal mounting ring and guard.

③ Additional hardware for flip lever units: Lockwasher with Teeth: 28309-523-26; 'C' Clamp Ring: B-31945.

Renewal Parts for 800H NEMA 4/4X Operators

Replacement Parts Bulletin 800H Nema 4/4X Potentiometer Units

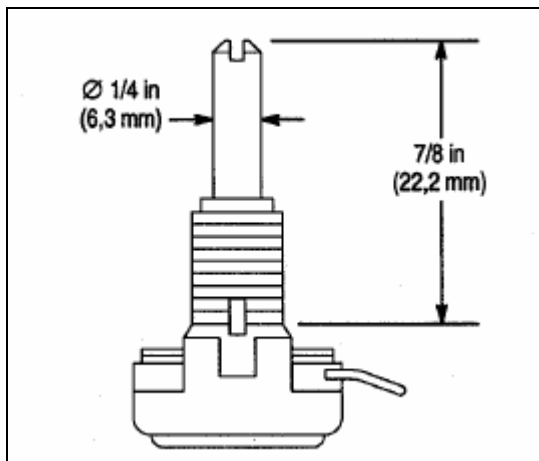
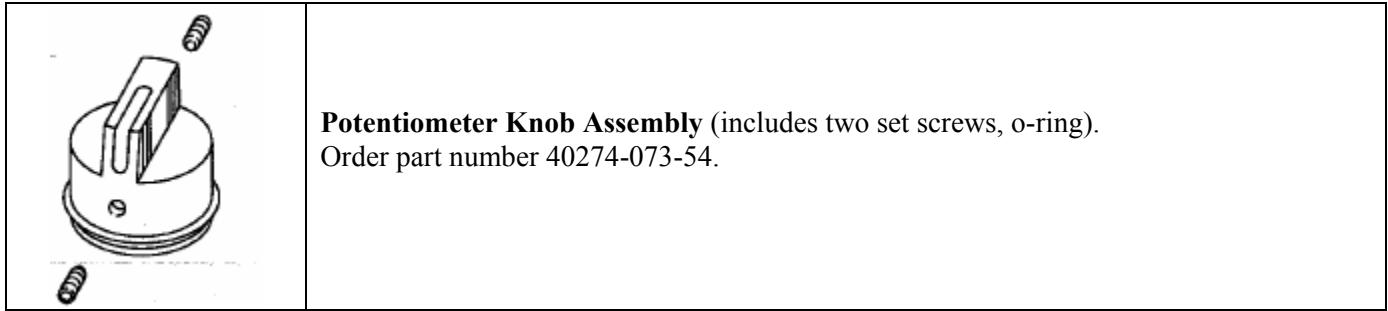

Resistive Element (Potentiometer)

Catalog Number	Replacement Potentiometer Unit	Resistance Value	Type of Taper
800H-UR4	24752-221-03	150 ohm, 2.25 watts	Linear
800H-UR12	24752-221-05	500 ohm, 2.25 watts	Linear
800H-UR13	24752-221-06	1K ohm, 2.25 watts	Linear
800H-UR16	24752-221-07	1.5K ohm, 2.25 watts	Linear
800H-UR19	24752-221-08	2.5K ohm, 2.25 watts	Linear
800H-UR24	24752-221-10	5K ohm, 2.25 watts	Linear
800H-UR29	24752-221-12	10K ohm, 2.25 watts	Linear
800H-UR34	24752-221-13	15K ohm, 2.25 watts	Linear
800H-UR35	24752-221-14	20K ohm, 2.25 watts	Linear
800H-UR37	24752-221-15	25K ohm, 2.25 watts	Linear
800H-UR41	24752-221-17	50K ohm, 2.25 watts	Linear
800H-UR46	24752-221-19	75K ohm, 2.25 watts	Linear
800H-UR49	24752-221-21	100K ohm, 2.25 watts	Linear
800H-UR50	24752-221-22	150K ohm, 2.25 watts	Linear
800H-UR51	24752-221-23	200K ohm, 2.25 watts	Linear
800H-UR54	24752-221-25	400K ohm, 2.25 watts	Linear
800H-UR55	24752-221-26	500K ohm, 2.25 watts	Linear
800H-UR56	24752-221-27	800K ohm, 2.25 watts	Linear
800H-UR57	24752-221-28	1 Meg ohm, 2.25 watts	Linear
800H-UR59	24752-221-29	2 Meg ohm, 2.25 watts	Linear
800H-UR62	24752-221-30	3 Meg ohm, 2.25 watts	Linear
800H-UR64	24752-221-31	4 Meg ohm, 2.25 watts	Linear
800H-UR90	24752-221-38	400K ohm, 2.25 watts	Linear
800H-UR91	24752-221-46	100K ohm, 2.25 watts	Modified Linear to 102 degrees, linear from 103 to 312 degrees

Modifications and Accessories

Contact Blocks

Packaged in kit form for field installation. All necessary mounting hardware is provided with each contact block kit. **Contact ratings are listed on page 10-59. Note:** It is not recommended to mount more than four contact blocks on any one Non-Illuminated operator, (maximum two blocks deep). Contact blocks cannot be stacked onto power modules, so illuminated operators are limited to two contact blocks. Sealed switch contact blocks are not stackable, and are limited to two blocks per operator. Time delay contacts are only available as one circuit per operator.



Number of Contacts	Shallow Block ①②	PenTUFF (Low Voltage) Block ①②	Logic Reed Block ③	Sealed Switch Block ④	Stackable Sealed Switch Block ⑤
	Cat. No.	Cat. No.	Cat. No.	Cat. No.	Cat. No.
1 N.O.	800T-XD1	800T-XD1V	800T-XD1R	800T-XD1P	800T-XD1Y
1 N.C.	800T-XD2	800T-XD2V	800T-XD2R	800T-XD2P	800T-XD2Y
1 N.O. (Early Make)	800T-XD3	800T-XD3V	—	—	—
1 N.C. (Late Break)	800T-XD4	800T-XD4V	—	—	—
1 N.O. - 1 N.C.	800T-XA	800T-XAV	800T-XAR	800T-XAP	800T-XAY
2 N.O.	800T-XA2 ④	—	800T-XA2R ④	—	800T-XA2Y
2 N.C.	800T-XA4	—	800T-XA4R	—	800T-XA4Y
1 N.C. (Late Break) 1 N.O.	800T-XA1	—	—	—	—
1 N.C. (Late Break) 1 N.C.	800T-XA7	—	—	—	—

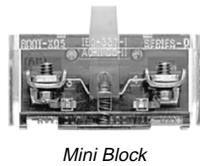

Mini Block



Time Delay Block

Number of Contacts	Mini Block ①	Time Delay Block ②
	Cat. No.	Cat. No.
1 N.O.	800T-XD5	800T-XT
1 N.C.	800T-XD6	800T-XS

- ① Contact blocks with normally closed contacts meet direct drive positive opening standard requirements when properly fused to IEC 269-1 and 269-2. Shallow/mini contacts: 10 A gl or N type cartridge fuse. PenTUFF contacts: 6 A gl or N type cartridge fuse.
- ② Specify Bulletin 800TC for finger-safe contact blocks. Example: **800TC-XA**.
- ③ 800T operator using sealed switch and logic reed contact blocks and installed in a suitable enclosure are UL Listed as suitable for use in Class I, Division 2/Zone 2 hazardous locations.
- ④ Additional contacts cannot be stacked on XA2 and XA2R contact blocks.
- ⑤ For contact ratings, see page 10-5.



Shallow Contact Block Hardware

Description	Cat. No.
① Contact Block Mounting Screw	800T-N335
② Screw Retainer	800T-N336
③ Actuator Extender	800T-N337

Modifications and Accessories, Continued

Power Modules

Packaged in kit form for field installation. Lamps are listed on page 10-47.

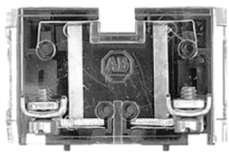

Full Voltage Power Module
 Cat. No. 800T-N330



Transformer Power Module
 Cat. No. 800T-N326

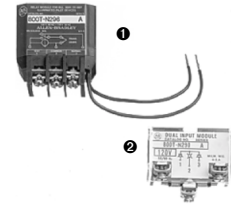

Dual Input Power Modules
 Cat. No. 800T-N296 (Transformer)
 800T-N290 (Diode)

Full Voltage		Transformer		Dual Input Kits (with Lamp)			
Voltage	Cat. No.	Voltage	Cat. No.	Type	Lamp	Voltage	Cat. No.
6 AC/DC	800T-N330	48 AC, 50/60 Hz	800T-N325	Transformer ❶	6V Incandescent	120 AC	800T-N296
12 AC/DC	800T-N330	120 AC, 50/60 Hz	800T-N326	Diode Type ❷	24V Incandescent	24 AC/DC	800T-N291
24 AC/DC	800T-N330	240 AC, 50/60 Hz	800T-N327	Diode Type ❷	90V Incandescent	120 AC/DC	800T-N290
120 AC/DC	800T-N330	480 AC, 50/60 Hz	800T-N328	Diode Type ❷	24V Red LED	24 AC/DC	800T-N343
240 AC/DC ❸	800T-N331	600 AC, 50/60 Hz	800T-N329	Diode Type ❷	24V Green LED	24 AC/DC	800T-N344
—	—	—	—	Diode Type ❷	24V Amber LED	24 AC/DC	800T-N345
—	—	—	—	Diode Type ❷	120V Red LED	120 AC	800T-N346
—	—	—	—	Diode Type ❷	120V Green LED	120 AC	800T-N347
—	—	—	—	Diode Type ❷	120V Amber LED	120 AC	800T-N348

- ❶ Transformer type dual input provides circuit isolation via a miniature type relay. This module is used in conjunction with a 120V transformer.
- ❷ Diode type dual input provides circuit isolation via opposing diodes. Not recommended for use with solid-state outputs and neon indicators.
- ❸ 240V full voltage module contains 50% dropping resistors for use with a 120V incandescent lamp

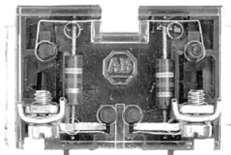

Resistor Power Module
 Cat. No. 800T-N332

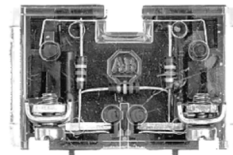

Neon Power Module
 Cat. No. 800T-N333

Resistor (10% Drop)		Neon ❹	
Voltage	Cat. No.	Voltage	Cat. No.
120 AC/DC	800T-N332	120 AC/DC	800T-N333
		240 AC/DC	800T-N334

- ❹ Neon modules contain resistors.

Modifications and Accessories, Continued

Replacement Color Caps

Color caps listed below are for field replacement on installed devices or for completion of devices ordered with color caps omitted.



Illuminated Extended Button



Standard Pilot Light

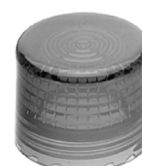

Push-to-Test Pilot Light

Illuminated Push Button Color Caps		Pilot Light Color Caps			
Color	Extended Button ❶	Color	Standard ❶	Color	Push-to-Test ❶
	Cat. No.		Cat. No.		Cat. No.
Red	800T-N40	Amber	800T-N26A	Red	800T-N40
Green	800T-N41	Blue	800T-N26B	Green	800T-N41
Amber	800T-N42	Clear	800T-N26C	Amber	800T-N42
Blue	800T-N43	Green	800T-N26G	Blue	800T-N43
White	800T-N44	Red	800T-N26R	White	800T-N44
Clear	800T-N45	White	800T-N26W	Clear	800T-N45

❶ Available in bulk quantities of 20. Add suffix (-BP) to the cat. no. and order in multiples of 20.



Non-Illuminated Plastic Mushroom



Non-Illuminated Plastic Jumbo Mushroom



Illuminated Mushroom



Illuminated Jumbo Mushroom

Push Button Color Caps, Non-Illuminated			Push Button Color Caps, Illuminated		
Color	Plastic Mushroom	Plastic Jumbo Mushroom	Color	Mushroom	Jumbo Mushroom
	Cat. No.	Cat. No.		Cat. No.	Cat. No.
Red	800H-N114A	800H-N115A	Red	800T-N304R	800T-N305R
Green	800H-N114B	800H-N115B	Green	800T-N304G	800T-N305G
Blue	800H-N114C	800H-N115C	Amber	800T-N304A	800T-N305A
Yellow	800H-N114E	800H-N115E	Blue	800T-N304B	800T-N305B
Orange	800H-N114F	800H-N115F	White	800T-N304W	800T-N305W
Gray	800H-N114G	800H-N115G	Clear	800T-N304C	800T-N305C
Black	800H-N114H	800H-N115H	—	—	—
White	800H-N114L	800H-N115L	—	—	—



Push-Pull



Push-Pull/Twist



Push-Pull Jumbo



Push-Pull/Twist Jumbo

Color	Push-Pull Color Caps, Non-Illuminated			
	Push-Pull	Push-Pull/Twist	Push-Pull Jumbo	Push-Pull/Twist Jumbo
	Cat. No.	Cat. No.	Cat. No.	Cat. No.
Red	800T-N160A	800T-N302A	800T-N208A	800T-N307A
Green	800T-N160B	800T-N302B	800T-N208B	800T-N307B
Blue	800T-N160C	800T-N302C	800T-N208C	800T-N307C
Yellow	800T-N160E	800T-N302E	800T-N208E	800T-N307E
Orange	800T-N160F	800T-N302F	800T-N208F	800T-N307F
Gray	800T-N160G	800T-N302G	800T-N208G	800T-N307G
Black	800T-N160H	800T-N302H	800T-N208H	800T-N307H
White	800T-N160L	800T-N302L	800T-N208L	800T-N307L

Modifications and Accessories, Continued

Replacement Color Caps, Continued

Color caps listed below are for field replacement on installed devices or for completion of devices ordered with color caps omitted.



Push-Pull



Push-Pull/Twist



Push-Pull Jumbo



Push-Pull/Twist Jumbo

Color	Push-Pull Color Caps, Illuminated			
	Push-Pull	Push-Pull/Twist	Push-Pull Jumbo	Push-Pull/Twist Jumbo
	Cat. No.	Cat. No.	Cat. No.	Cat. No.
Amber	800H-N112A	800T-N301A	800T-N209A	800T-N306A
Blue	800H-N112B	800T-N301B	800T-N209B	800T-N306B
Clear	800H-N112C	800T-N301C	800T-N209C	800T-N306C
Green	800H-N112G	800T-N301G	800T-N209G	800T-N306G
Red	800H-N112R	800T-N301R	800T-N209R	800T-N306R
White	800H-N112W	800T-N301W	800T-N209W	800T-N306W

Selector Switch Knobs, Illuminated



Standard Knob



Knob Lever

Color	Knob Type	
	Standard Knob	Knob Lever
	Cat. No.	Cat. No.
Amber	800H-N154A	800H-N155A
Blue	800H-N154B	800H-N155B
Clear	800H-N154C	800H-N155C
Green	800H-N154G	800H-N155G
Red	800H-N154R	800H-N155R
White	800H-N154W	800H-N155W

Booted Non-Illuminated Selector Switch Knobs

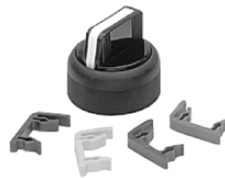

Booted Selector Switch Knob
 Cat. No. 800H-NR5

Insert Material	Material			
	Hypalon	Silicone ●	Urethane ●●	Ethylene ● Propylene ●●
	Cat. No.	Cat. No.	Cat. No.	Cat. No.
Brass	800H-NR5 ①	800H-NR101 ①	800H-NR100 ①	800H-NR103 ①
Stainless Steel	800HS-NR5	800HS-NR101	800HS-NR100	800HS-NR103

① Color insert packet (Cat. No. 800T-N123) is included in each kit.

Modifications and Accessories, Continued

Protective Boots



Cat. No. 800H-N11



Cat. No. 800H-N12

Protective Boot for Illuminated Push Buttons

Description	Type	Cat. No.
May be added to guarded units, units without guard or push-to-test devices. This protective silicone boot guards against the entrance of foreign materials reaching the opening between the button and locking ring.	Boot without Guard	800H-N11
	Boot with Guard	800H-N12

Boots supplied with control stations and components are made of a hypalon material with brass insert ring. To order boots with silicone, urethane or ethylene-propylene material, see table below.



Protective Boot for Push Button
 Cat. No. 800H-N5A

Insert Material	Color	Material			
		Hypalon	Silicone ● ①	Urethane ●● ①	Ethylene ● Propylene ●● ①
		Cat. No.	Cat. No.	Cat. No.	Cat. No.
Brass	Red	800H-N5A	800H-N101R	800H-N100R	800H-N103R
	Green	800H-N5B	800H-N101G	800H-N100G	800H-N103G
	Black	800H-N5H	800H-N101B	800H-N100B	800H-N103B
	Yellow	800H-N5E	800H-N101Y	800H-N100Y	—
	Blue	800H-N5C	800H-N101BL	800H-N100BL	—
Stainless Steel	Red	800HS-N5A	800HS-N101R	800HS-N100R	800HS-N103R
	Green	800HS-N5B	800HS-N101G	800HS-N100G	800HS-N103G
	Black	800HS-N5H	800HS-N101B	800HS-N100B	800HS-N103B
	Yellow	800HS-N5E	800HS-N101Y	800HS-N100Y	—
	Blue	800HS-N5C	800HS-N101BL	800HS-N100BL	—

① Dots printed on inside of boots identify type of boot material.

Protective Boot Application Information

• **Hypalon (synthetic rubber)**

Very resistant to attack by oxidizing chemicals such as concentrated sulfuric acid and hypochlorite solutions. Also resistant to attack by oils and performs well in a wide range of other chemicals and solvents. Good flex and high impact resistance. This is the standard boot material supplied with 800H NEMA Type 4/4X push buttons unless otherwise specified.

• **Silicone**

Superior high temperature resistance. Particularly suited for use where organic acids or vegetable oils may be present. Also superior resistance to the effects of outdoor use, such as oxygen, ozone, and weather.

• **Urethane**





Excellent resistance to mechanical failure. Most durable boot material. Particularly suited for use where lubricating oils and automotive fuels may be present. Also well-suited for outdoor use.

• **Ethylene-propylene**

Particularly suited for high temperature applications. Resistant to attack by many acids and alkalis, detergents, phosphate esters, ketones, alcohols, and glycols. Outstanding service in areas with hot water and steam wash-downs.

Modifications and Accessories, Continued

Miscellaneous

 <p><i>Closing Button Cat. No. 800T-N1</i></p>	<p>Description</p> <p>Closing Button Where an enclosure or flush plate with more than the required number of openings is used, this neat appearing button can be supplied to close the unused openings.</p>	<p>Color</p> <p>Gray</p> <p>Black</p>	<p>Cat. No.</p> <p>800T-N1</p> <p>800T-N1B</p>
 <p><i>Engraved E-Stop Jumbo Push-Pull Cap Cat. No. 800T-N209RE1</i></p>	<p>Description</p> <p>Engraved Jumbo Push-Pull Cap For use on Bulletin 800T or 800H push-pull operators. Fits on illuminated and non-illuminated devices.</p>	<p>Cat. No.</p> <p>800T-N209RE1</p>	
 <p><i>Mounting Ring Wrench Cat. No. 800T-N245</i></p>	<p>Description</p> <p>Mounting Ring Wrench This wrench will simplify tightening or loosening the octagonal mounting ring used on Bulletin 800H units. This wrench is double ended and can be used for 18 mm and 30 mm pilot light mounting rings.</p>	<p>Cat. No.</p> <p>800T-N245</p>	
 <p><i>Replacement Knobs and Mounting Rings</i></p>	<p>Description</p> <p>Mounting Rings Illuminated push button or push-pull mounting ring</p> <p>Guarded push button mounting ring; also converts flush to guarded</p> <p>Mounting ring for flush and extended non-illuminated operators</p> <p>Selector switch knob and mounting ring</p>	<p>Type</p> <p>Type 1</p> <p>Type 2</p> <p>Type 3</p> <p>Type 4</p>	<p>Cat. No.</p> <p>800H-N142</p> <p>800H-N143</p> <p>800H-N144</p> <p>800H-N145F</p>
 <p><i>Color Insert Kits Cat. No. 800T-N123</i></p>	<p>Description</p> <p>Color Insert Kits Available on selector switches with removable color inserts. Standard knob and knob levers use the same insert. If color All is selected, a packet of color inserts will be furnished which includes one of each color except orange. Color insert kits can also be ordered with operators at no additional charge.</p>	<p>Color</p> <p>Red</p> <p>Green</p> <p>Blue</p> <p>Yellow</p> <p>White</p> <p>Orange</p> <p>All</p>	<p>Cat. No.</p> <p>800T-N124</p> <p>800T-N125</p> <p>800T-N126</p> <p>800T-N127</p> <p>800T-N128</p> <p>800T-N286</p> <p>800T-N123</p>

Important User Information

Because of the variety of uses for the products described in this publication, those responsible for the application and use of this control equipment must satisfy themselves that all necessary steps have been taken to assure that each application and use meets all performance and safety requirements, including any applicable laws, regulations, codes and standards.

The illustrations, charts, sample programs and layout examples shown in this guide are intended solely for purposes of example. Since there are many variables and requirements associated with any particular installation, Rockwell Automation does not assume responsibility or liability (to include intellectual property liability) for actual use based upon the examples shown in this publication.

Allen-Bradley publication SGI-1.1, *Safety Guidelines for the Application, Installation and Maintenance of Solid-State Control* (available from your local Allen-Bradley office), describes some important differences between solid-state equipment and electromechanical devices that should be taken into consideration when applying products such as those described in this publication.

Reproduction of the contents of this copyrighted publication, in whole or part, without written permission of Rockwell Automation, is prohibited.

Throughout this document we use notes to make you aware of safety considerations:

ATTENTION

Identifies information about practices or circumstances that can lead to personal injury or death, property damage or economic loss



IMPORTANT

Identifies information that is critical for successful application and understanding of the product.

Use only replacement parts and devices recommended by Rockwell Automation to maintain the integrity of the equipment. It is the user's responsibility to ensure that the renewal part number selected is properly matched to the model, series and revision level of the equipment being serviced.

ATTENTION

Servicing energized Industrial Control Equipment can be hazardous. Severe injury or death can result from electrical shock, burn, or unintended actuation of controlled equipment. Recommended practice is to disconnect and lockout control equipment from power sources, and release stored energy, if present.



Refer to **National Fire Protection Association Standard No. NFPA70E, Part 2** and (as applicable) **OSHA rules for Control of Hazardous Energy Sources (Lockout/Tagout) and OSHA Electrical Safety Related Work Practices** for safety related work practices, including procedural requirements for lockout/tagout, and appropriate work practices, personnel qualifications and training requirements where it is not feasible to de-energize and lockout or tagout electric circuits and equipment before working on or near exposed circuit parts.

ROCKWELL DISCLAIMS ALL WARRANTIES WHETHER EXPRESSED OR IMPLIED IN RESPECT TO THE INFORMATION (INCLUDING SOFTWARE) PROVIDED HEREBY, INCLUDING THE IMPLIED WARRANTIES OF FITNESS FOR A PARTICULAR PURPOSE, MERCHANTABILITY, AND NON-INFRINGEMENT. Note that certain jurisdictions do not countenance the exclusion of implied warranties; thus, this disclaimer may not apply to you.

Allen-Bradley is a trademark of Rockwell Automation